

Knight®

Product Details

Haven Fixed Desk



Haven Fixed Desk



FEATURES

- Precision-engineered steel frame with a durable powdercoat finish
- 50 x 80mm rectangular leg profile with a 670mm foot
- 25mm commercial-grade top with melamine finish and 2mm PVC edging
- Overall height 730mm
- Optional extendable cable tray (soft-wiring not included)
- Compatible with Studio50, Active25 and Dart E-panel screens

Haven fixed desking is a smarter way to work. Designed in Germany and built for performance, this versatile range brings durability, functionality, and ergonomic comfort to any workspace, whether it's a home office or a large-scale fit-out. BIFMA and Green Tag certified, Haven delivers trusted quality that's easy to specify and ready to perform.



PROFILES

Rectangle

1200 x 700mm, 1500 x 800mm, 1600 x 800mm, 1800 x 800mm

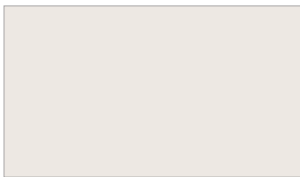

TOP STYLES

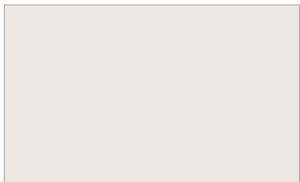

RECTANGLE*

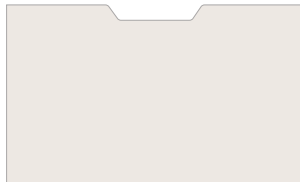

SCALLOP*

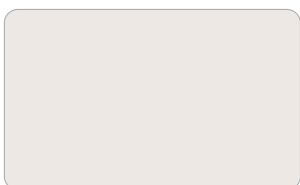

RADIUS (100MM)

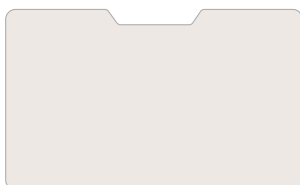

SCALLOP & RADIUS (100MM)

FINISHES

Tops MELAMINE



WHITE



SILVER



NORDIC
MAPLE

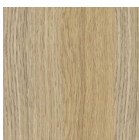

ATLANTIC
OAK



BLACK

Frame POWDERCOAT



WHITE

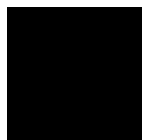

BLACK

OPTIONAL UPGRADES

Cable Tray

Cable Tray & Screen Brackets



Cable Bridge



Studio50 Screen

Active25 Screen

Dart E-panel

Monitor Arm

* Silver is available only in the top styles indicated.

DIMENSIONS (MM)

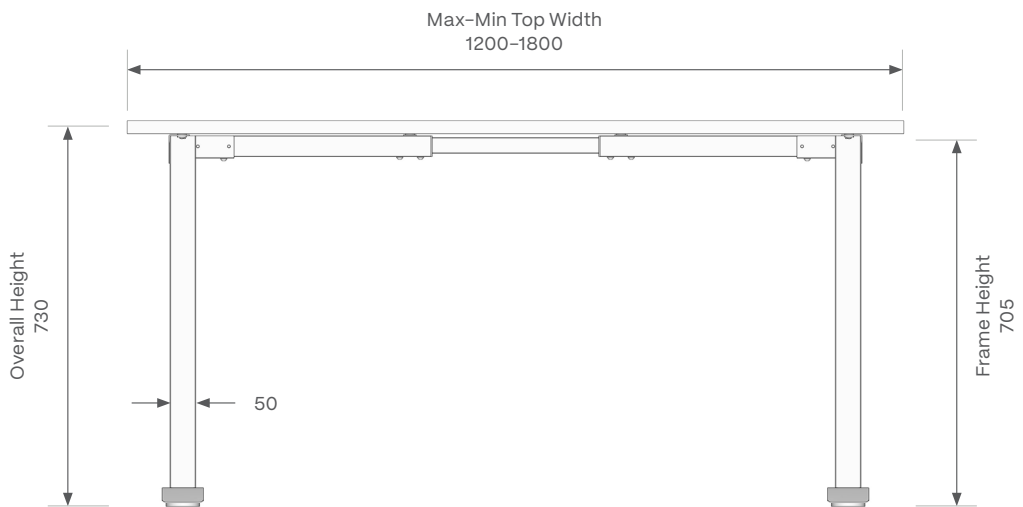
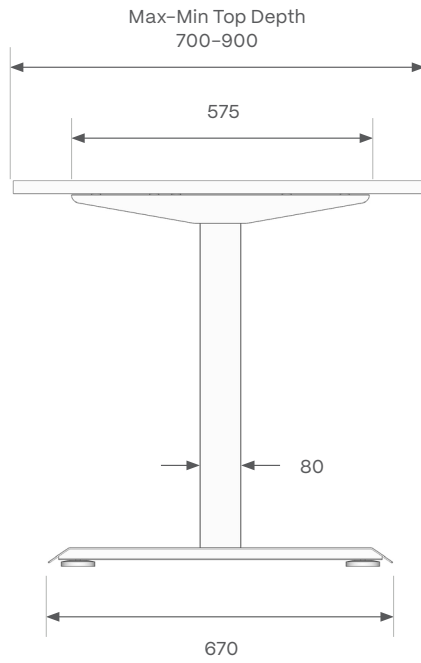

Smarter Workspaces

NEW PLYMOUTH
Head Office/Showroom
59 Rimu Street
New Plymouth 4312

AUCKLAND
Showroom
Appointment only

0800 143 143
info@knightgroup.co.nz